

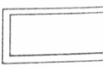











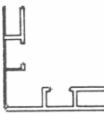



MANUÁL K ZAHRADNÍMU PAŘENIŠTI - D04105



Děkujeme, že jste si zakoupili produkt u našeho e-shopu. Prosíme o pečlivé prostudování následního manuálu.

SEZNAM DÍLŮ

Díl	Číslo	Mn.
	W1	2
	W2	4
	W3	2
	1	2
	2	2
	4	2
	5	2
	10L	2
	10R	2
	6R	2
	6L	2
	7	1
	8	2
	S2	2
	S6L	2
	S6R	2

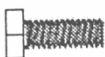
Díl	Číslo	Mn.
	B1	4
	B2	2
	B3	2
	B4	2
	F1	8
	F2	34
	F3	4
	F4	4

PC	P1	2
	P2	2
	P3R	2
	P3L	2

VŠEOBECNÉ BEZPEČNOSTÍ POKYNY

Návod k obsluze je třeba před prvním použitím přístroje kompletně přečíst. Před montáží prosím zkontrolujte, že máte všechny díly, dle seznamu součástek a pečlivě si nastudujte následující postup, abyste jednotlivé díly nepoškodili nepatřičnou manipulací.

NA CO DÁVAT POZOR PŘI MONTÁŽI PAŘENIŠTĚ

- **POČASÍ:** pro montáž pařeniště si vyberte den, kdy nebude příliš silně foukat vítr a nebude pršet. Pařeniště nestavte na mokřem a zabláceném podkladu.
- **BEZPEČNOSTÍ UPOZORNĚNÍ:** hliníkovou konstrukcí se nikdy nedotýkejte volně ležících kabelů či drátů elektrického napětí. Při sestavování konstrukce použijte ochranné rukavice a brýle. S plastovými částmi zacházejte velmi opatrně a držte je z dosahu malých dětí. Neopírejte se ani netlačte na konstrukci během její montáže. Během montáže držte malé děti v dostatečné vzdálenosti od všech částí a příslušenství, aby nedošlo k poranění.
- **VÝBĚR MÍSTA:** pařeniště musí být umístěno na rovné ploše a pevně zajištěno, aby ho ani velký vítr nepoškodil. Pro umístění pařeniště vyberte slunné místo, které nestíní stromy.
- **MATERIÁL:** tento materiál není součástí dodávky a je nutný pro konstrukci pařeniště.
 - silikon jako těsnící hmota
 - rýč/lopata
 - křížový šroubovák
 - lepící páska
 - nůžky, kladivo, nebozez
 - pracovní rukavice
 - vodováha
 - mazivo
 - kladivo s gumovou palicí





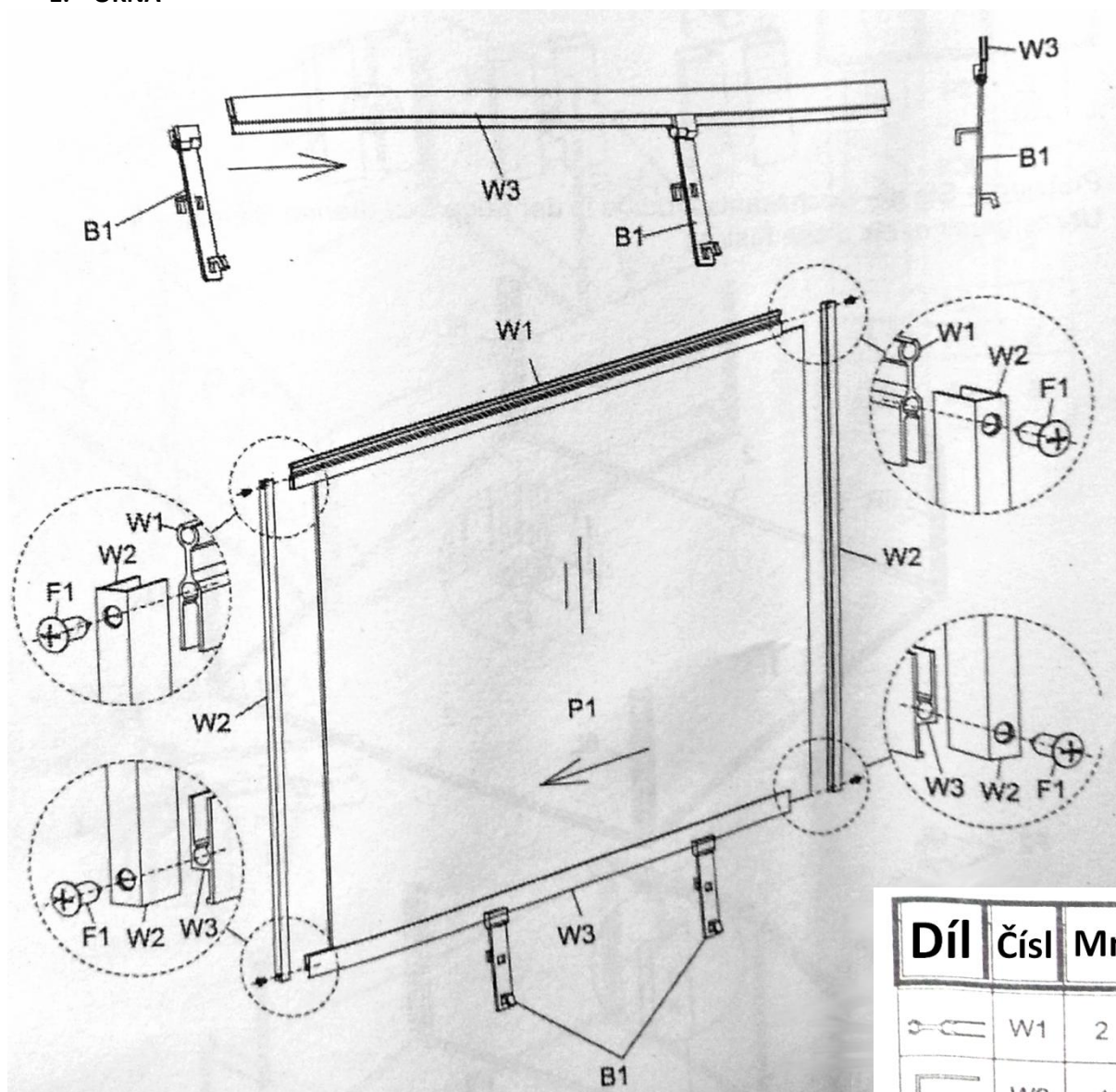

OCHRANA A ÚDRŽBA

ÚDRŽBA: pařeniště umívejte pouze vlažnou vodou a mírným saponátem. V žádném případě nepoužívejte aceton, nebo jiné specializované čisticí látky.





STŘECHA: Ze střechy ometejte sníh, který by ve velkých vrstvách mohl střechu poškodit.

1. OKNA

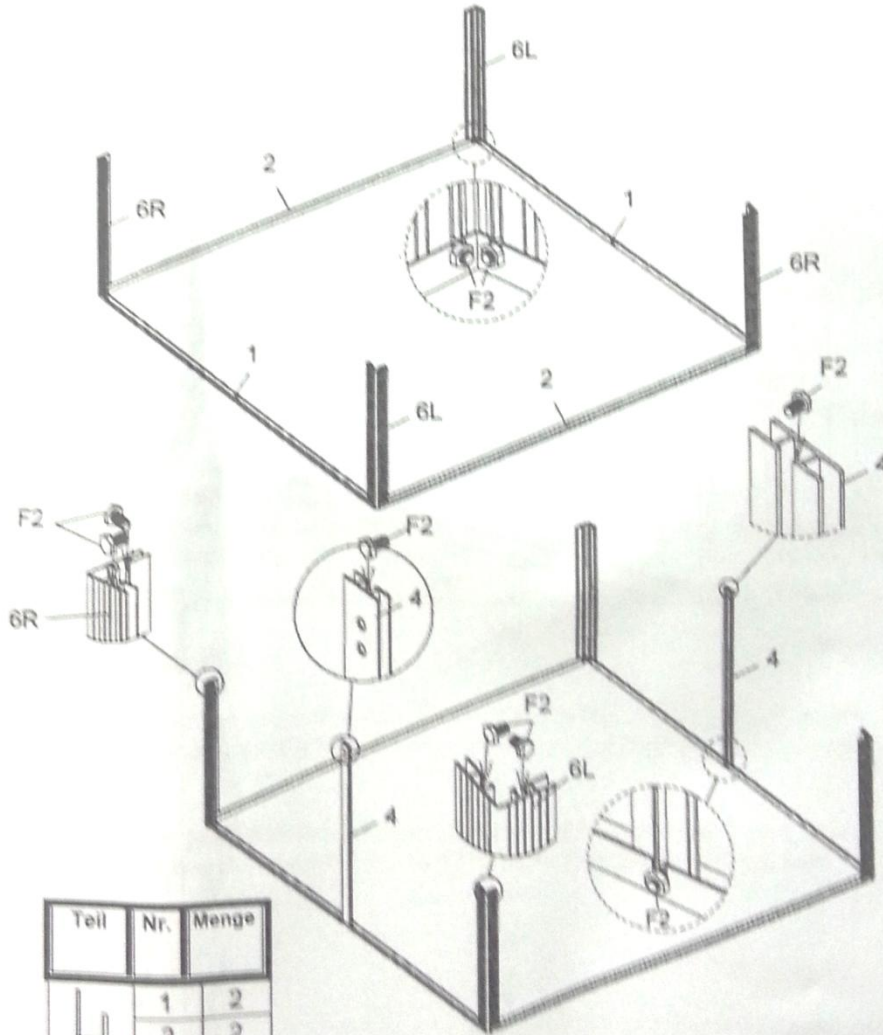

Díl	Čísl	Mn.
	W1	2
	W2	4
	W3	2
	P1	2
	B1	4
	F1	8



Teil	Nr.	Menge
	1	2
	2	2
	6L	2
	6R	2
	4	2
	F2	20

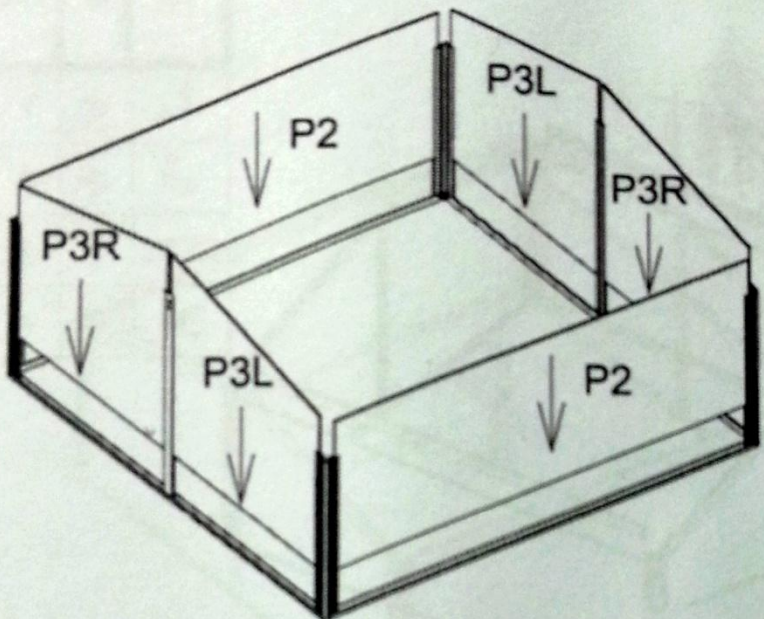



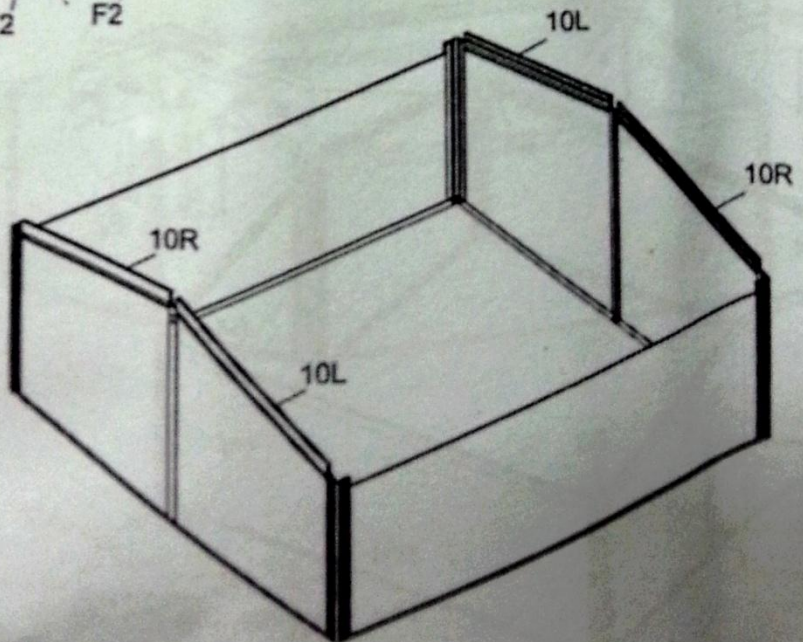
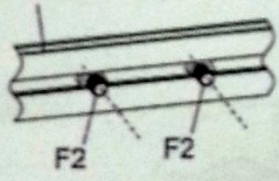

Teil	Nr.	Menge
	P2	2
	P3L	2
	P3R	2
	10L	2
	10R	2
	F2	8

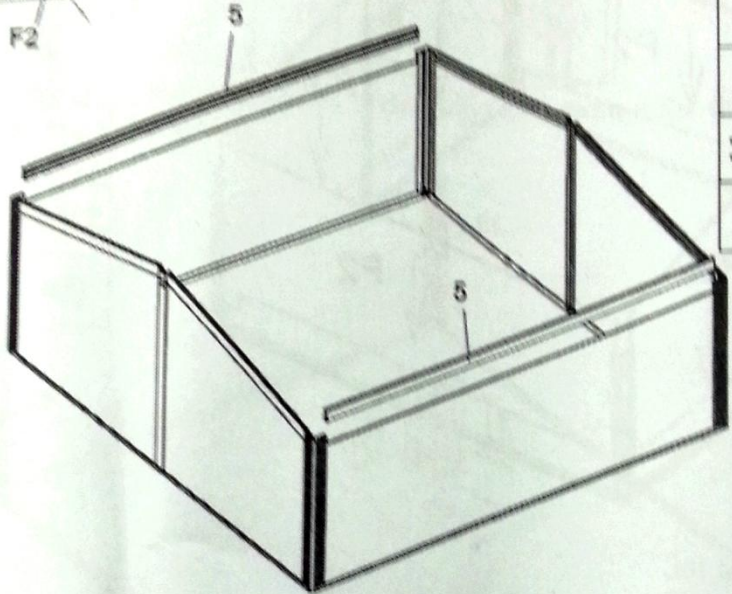
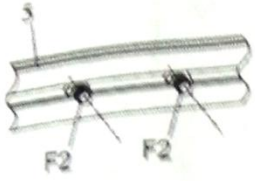
F2(2PCS) 10R and 10L







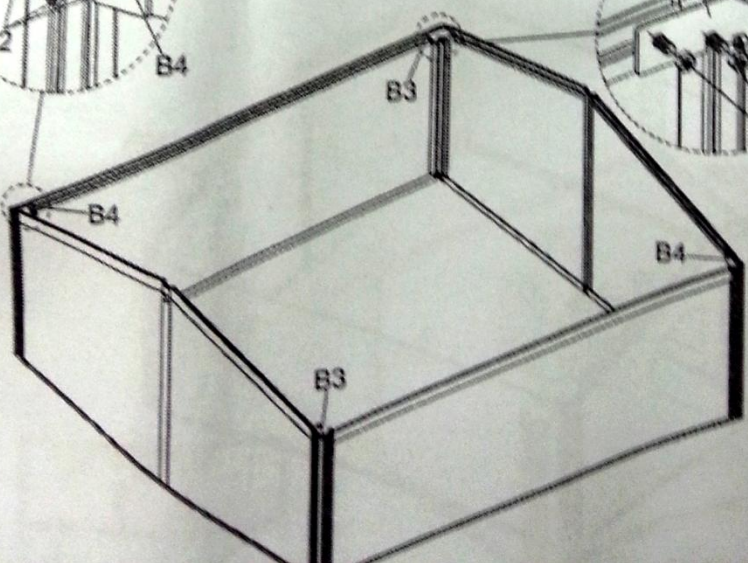
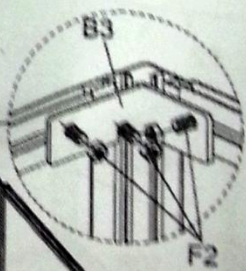
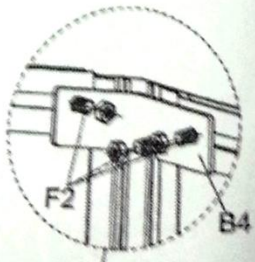

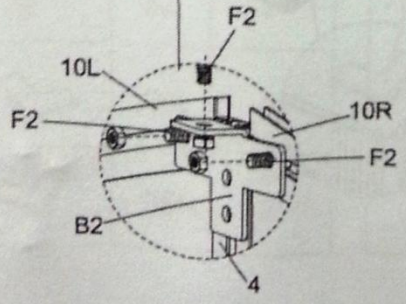
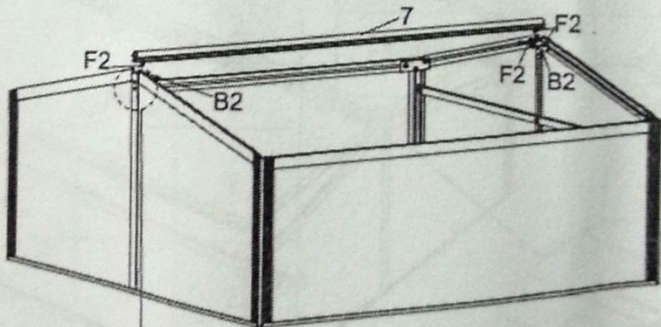
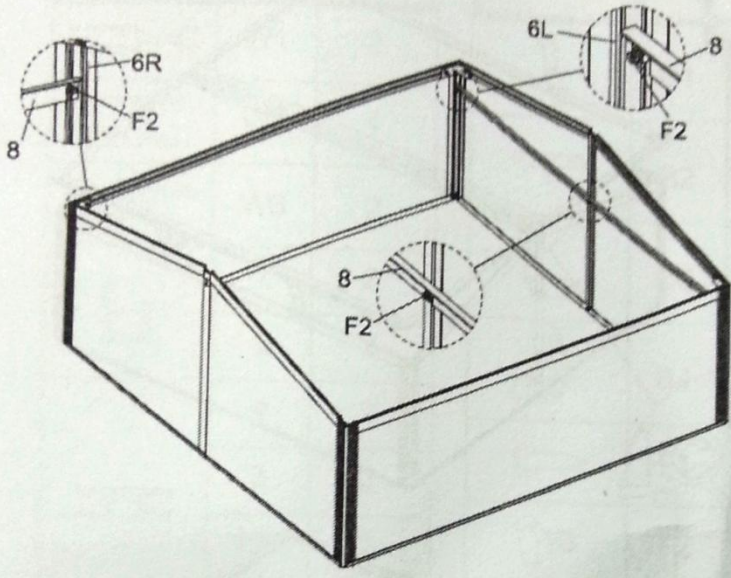



Teil	Nr.	Menge
	B3	2
	B4	2
	5	2
	F2	4





Teil	Nr.	Menge
	8	2
	7	1
	B2	2
	F2	2

Teil	Nr.	Menge
	S2	2
	F3	4
	F4	4
	S6L	2
	S6R	2

