

IMPORTANT INSTRUCTIONS PRIOR TO INSTALLATION	4
SAFETY INSTRUCTIONS	6
DESCRIPTION OF APPLIANCE	8
INCLUDED ACCESSORIES	8
MOUNTING THE INDOOR AND OUTDOOR APPLIANCES	10
MOUNTING THE INDOOR APPLIANCE	12
INSTALLATION OF THE CONDENSATION DRAINAGE HOSE	13
INSTALLATION OF THE INDOOR APPLIANCE	14
SELF-INSTALLATION FOR QUICK CONNECT LINES	15
START-UP	20
CUSTOMER SERVICE AND WARRANTY	21

INSTALLATION INSTRUCTIONS

INSTALLATION INSTRUCTIONS



READ THESE INSTRUCTIONS CAREFULLY BEFORE YOU START UP OR USE THIS MACHINE!

Warranty becomes void if the equipment is not used, set up, or maintained according to the instructions or if the machine design is changed by third parties. The right to changes is reserved!

WARNING

- Do not install, remove, or reinstall the AC split appliance yourself. This work must be performed by qualified technicians!
- Incorrect installation may result in water leaks, electric shock, or fire. Please let authorised technicians perform the installation. Warranty does not apply to defects due to incorrect installation.
- The appliance should be installed at a location with easy access. The customer is responsible for all additional costs for special equipment.
- Keep these operating instructions in the immediate vicinity of or on the appliance.
- If you have any questions, please contact customer service at the phone number indicated on the back.

IMPORTANT INSTRUCTIONS PRIOR TO INSTALLATION

There are some basic rules to be adhered to when setting up the indoor appliance and installing the coolant lines to ensure that the performance of the appliance is not affected:

- Make sure the technical components of the indoor appliance technology match the outdoor appliance parts.
- The use of third-party components will void the warranty.
- Bring the appliance as closely as possible to the installation location in its original packaging to prevent transport damages.
- Check the contents of the packaging for completeness and inspect the appliance for visible transport damage.
- Report any defects to your contractual partner and the shipper immediately. Later complaints cannot be accepted.
- Lift the indoor appliance at its corners, not at the coolant or condensation connections.
- Select a mounting location that provides free air supply and discharge and where the appliance is not exposed to direct sunlight or other heat sources.
- Make sure that the air distribution is optimal and draft-free and in compliance with minimum clearances.
- Prior to the installation, make sure that the electrical connection values comply with the data on the type plate and perform all electrical connections according to the applicable DIN and VDE regulations.
- Make sure that the electrical connections are properly installed on the terminals.
- Never bend the coolant lines and do not indent them.
- Make sure that the heat insulation for all coolant lines, including all connectors and valves, is diffusion-proof.

-
- Seal off open coolant lines with suitable caps or tape to protect them from moisture.
 - Do not remove the safety caps until just before you connect them to the coolant lines.
 - For the installation, the device must be precisely levelled using a level to prevent condensate leakage.
 - Check levelling upon completion of the installation.

SAFETY INSTRUCTIONS



This appliance was subject to comprehensive material, function, and quality checks prior to its delivery. The appliance must exclusively be used according to the instructions. Unauthorised use may cause danger.

COMPLIANCE WITH THE FOLLOWING INSTRUCTIONS IS MANDATORY:

- The indoor appliance is not suitable for outdoor operation.
- The person trained to operate the appliance must check the appliance for visible defects on operating or safety equipment and ensure the presence of safeguards prior to start-up!
- Always disconnect the appliance from power and protect it against unauthorised restarting before working on it.
- The appliance may only be used after it has been mounted and only according to its intended use.
- Removal of covers, safety screens, etc. while the appliance is in operation is not permitted and may lead to uncontrolled operating conditions.
- Always operate the appliance within the approved operating ranges (ambient temperatures).
- Make sure that the safety distance to flammable objects is sufficient.
- Do not install the air conditioner near heaters.
- Make sure that the air supply and exhaust openings are free of foreign objects at all times and do not insert foreign objects into the openings of the appliance.
- Always connect the appliance to a properly installed and compliant grounded power supply.
- Do not operate the appliance at hazardous locations. The appliance is not suitable for use in very dusty or aggressive air.
- Do not use flammable aerosols, such as hairspray or lacquer spray, in the immediate vicinity of the appliance.
- Do not operate the appliances in an atmosphere containing oil, sulphur and salt.
- Do not expose the appliance to direct water jets.
- Protect the appliance and remote control from moisture and direct sunlight.
- Protect all electric cables and connecting lines from damage, including damages caused by animals.
- Never open the appliance housing. There is a danger of electric shock.
- Check for unobstructed condensation drainage regularly.
- Never operate the appliance without an air filter.
- Make sure that the outdoor unit is equipped with restart protection through the indoor unit that will prevent immediate restarts after shutting the appliance off to prevent compressor damage. The appliance cannot be restarted until 3 minutes have elapsed.
- Optimal appliance function is only warranted at indoor temperatures between 16 and 30° C.
- The operator or a qualified technician assigned by the operator may perform cleaning tasks and minor maintenance work according to the tasks outlined in the "Care and Maintenance" section.
- Protect the remote control from major vibrations.

-
- Do not mount the appliance yourself. Incorrect mounting may result in electric shock, fire or water leakage. Contact your dealer or installer.
 - Carefully mount the appliance according to these installation instructions. Improper mounting may cause damage such as electric shock, fire, or water leakage.
 - Mount the appliance at a safe location that will support the weight of the appliance. The appliance may otherwise fall down and cause bodily injury.
 - Perform electrical work according to the installation instructions and make sure that you are using an external power circuit. Insufficient power capacity or incomplete electrical work may result in fire or electric shock.
 - Use the special cables to safely connect the indoor unit with the outdoor unit and tighten the cables at the connection box; however, there should not be any tension between the cables.
 - Make sure that the coolant does not leak or escape at an improperly screwed on valve after mounting. A reduction of coolant will cause limited or improper operation of the air conditioner.
 - Only use the supplied parts or special parts for installation. The use of low quality materials may lead to injuries caused by fire, electric shock, or dropping the unit.
 - Make sure that the covers for the connections are tightly reinstalled after the electrical wiring has been installed. Contact with dust, water, etc. may cause electric shock or fire.
 - Do not mount the appliance where it will be exposed to leaking flammable gases. If the gases leak in the vicinity of the appliance, an explosion may occur.
 - Connect the condensation drainage hose according to the installation instructions. Incorrect installation may cause water to leak and thereby damage other household appliances.
 - This split appliance is not suitable for winter operation. The appliance must be equipped with a winter control for such operation. For more information, contact the hotline listed in the operating instructions.
 - Use in server rooms: These air conditioners are generally not suitable for use in server rooms. However, the appliance may be retrofitted. Please contact our hotline listed on the back. In addition, you should ask our hotline to determine the required capacity.

DESCRIPTION OF APPLIANCE

The operation of the air conditioner is simple: Heat is extracted from the room to be "cooled". The heat is transported by the environmentally friendly coolant R 407C or R410A.

The appliance is primarily intended to cool rooms. In addition, it filters and dehumidifies the air and thereby provides a comfortable climate in the room. When using outdoor units that are equipped with the Cooling-Heating operating mode, the appliance may be used for heating during transitional periods. The appliance also offers pure ventilation and dehumidifying operation.

The appliance operates fully automated and offers a variety of options, thanks to its microprocessor control.

It is easily operated with the supplied remote control.

TRANSPORT AND PACKAGING

The appliance is delivered in strong transport packaging made of cardboard or styrofoam.

Please check the appliance upon delivery and note any damages or missing parts on the delivery slip and notify the shipper and your contractual partner immediately.

Later complaints are not covered by the warranty.

INCLUDED ACCESSORIES

No.	Name	Quantity			
1	Installation plate	1			
2	Temporary bolt ST3.9 x 25-C-H	4			
3	Dowel	4			
4	Coolant pipe	Liquid side	Ø 6.35	5 m	
		Gas side	≤ 10000 BTU/h	Ø 9.53	5 m
		Gas side	≤ 10000 BTU/h	Ø 12.00	5 m
5	Tubular feed-through with collar	1			
6	Condensation drainage hose	1			
7	Cable tie	8			

No.	Name	Quantity
8	Electrical connecting cable	1
9	Drain plug for outdoor unit	1
10	Remote control	1
11	Holder for remote control	1
12	Electrical tape	1
13	Installation kit sealant (for wall breakthrough)	1

Note:

A hex wrench is also required to install the air conditioner. This wrench is not included in the delivery.

The air conditioner must be connected to a power supply with an impedance not exceeding 0.26 Ohms. When in doubt, contact the power company for information about the impedance of the system.

Anchor bolts to install the outdoor unit.

- Do not expose the outdoor unit to strong winds.
- Install the outdoor unit using anchor bolts with \varnothing 10 or \varnothing 8

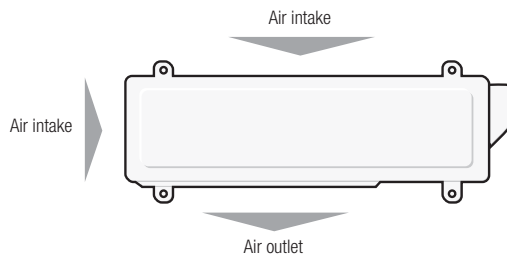

This illustration is intended for the purpose of explanation only
Remove insulation from copper connecting pipe

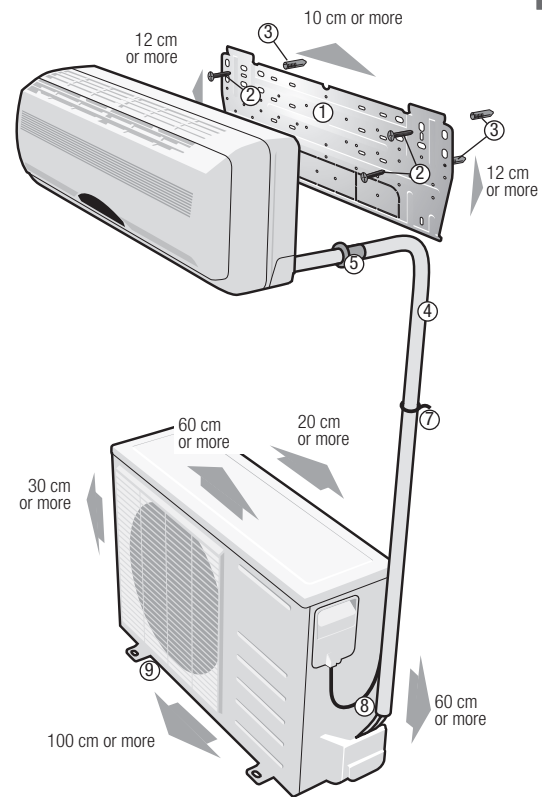

INSTALLATION OF THE INDOOR AND OUTDOOR UNITS

READ THESE STEP-BY-STEP INSTALLATION INSTRUCTIONS CAREFULLY

- Read these installation instructions prior to installation to perform the installation properly
- All illustrations are drawings. In the event of variances between the illustrations in these instructions and the actual air conditioner, the actual appliance takes precedence.
- No moisture or dirt may enter the adapter pipes and connections during the installation of coolant lines. Always install the outdoor lines in dry weather. Do not remove the sealing caps and plugs until immediately prior to installation. The installation must be performed in the sequence outlined below.
- Non-compliance with the individual installation steps according to these instructions and subsequent damage to the air conditioner will void any liability and warranty.



CAUTION

The coolant lines should not be disconnected again after opening the stop valves on the outdoor air conditioner because this may cause the coolant to leak and the operation of the air conditioner will no longer be warranted.

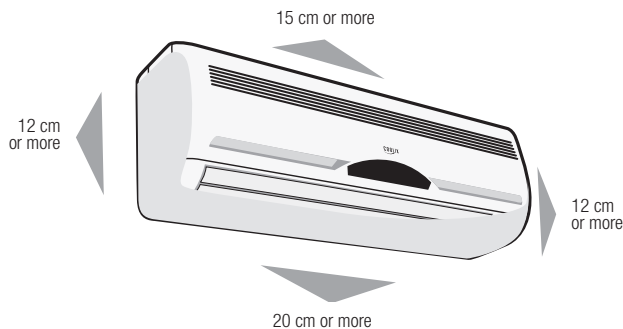

INDOOR UNIT

- Do not set up the indoor unit subject to heat or steam.
- Select a location without obstructions in front of and around the appliance.
- Make sure that the water is drained downward.
- Do not install the appliance at a door entrance.
- Make sure that the left and right clearances are greater than 10 cm.
- The distance of the indoor appliance from the ceiling should be at least 10 cm.
- When the pipe connection is extended, the coolant quantity must be adjusted accordingly.
- The pipe must be installed to the left of the indoor unit.

OUTDOOR UNIT

- If there is an awning above the outdoor unit to protect the appliance from direct sunlight or rain, make sure that it does not limit the heat radiation from the condenser.
- Make sure that the clearance behind the appliance and to the left of the appliance measures more than 30 cm. The clearance in front of the appliance must be greater than 100 cm and more than 60 cm at the connecting side (to the right of the appliance).
- In addition, the floor clearance should be 20 cm so that the condensation water can drain during heating operation in the winter without a problem.
- No objects may be present in the area of air intake and air outlet openings.
- Take the weight of the appliance into consideration and select a location without interference from noise and vibration.
- Select a location where noise and warm air will not disturb your neighbour.
- Do not install the appliance in a light well because there will be no air exchange.

ROOF INSTALLATION

- If the unit is to be mounted on a roof, make sure that it is in a level position and that the roof can bear the weight of the outdoor unit.
- Make sure that the roof structure and anchoring is suitable for this outdoor appliance.
- Consult the local authorities to mount the appliance on the roof.
- Take the subsequent noise and vibration into consideration before installing the appliance on a roof or in an attic.
- The appliance must provide easy access for service at all times.
- Install the appliance on a sloped roof so that it can later be serviced without having to step onto the sloped roof.

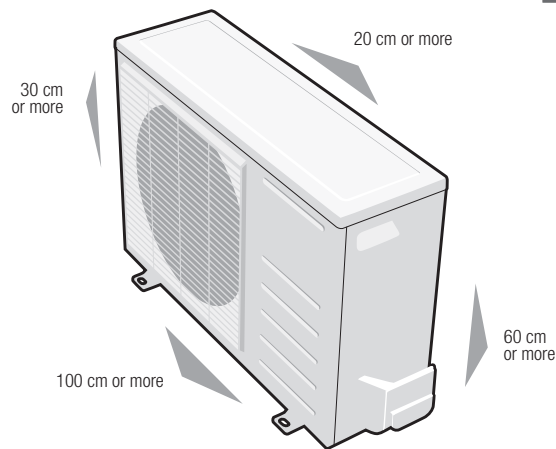

MOUNTING THE INDOOR UNIT

1. INSTALLATION OF THE MOUNTING PLATE

- Install the mounting plate horizontally on a level surface on the wall and leave a great enough space surrounding the mounting plate.
- If the wall is made of concrete, brick, or similar material, drill four holes with a diameter of 6 mm into the wall. Insert the mounting brackets for the corresponding screws.
- Use 4 screws to install the mounting plate on the wall.
- Always use a level to mark the drill holes and align the mounting plate.
- Use the level to check the mounting plate after screwing it into the wall to make sure it is truly level.

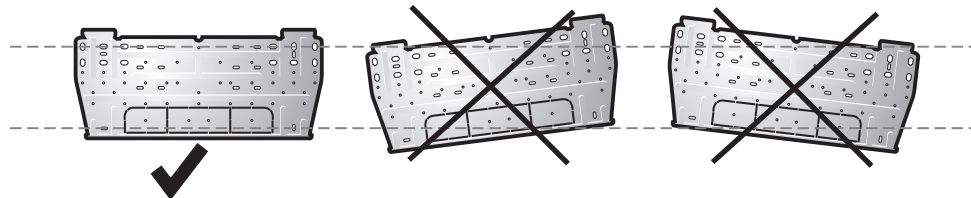

Note:

Install the mounting plate and holes in the wall according to the structure of the wall and the fastening points of the mounting plate.

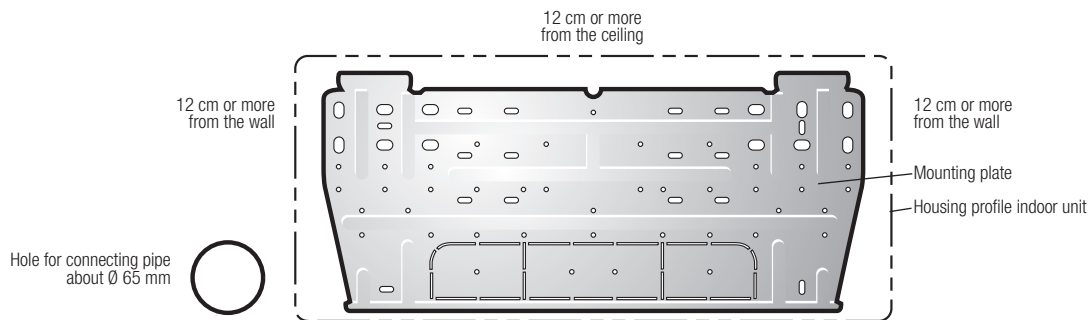

2. BORE IN THE WALL

- Determine the drilled holes according to the illustration.
- Bore a hole with a diameter of about 65 mm sloped toward the outside.
- Use pipe liner (plastic pipe) when drilling through metal screen or metal plates to shield the electric wiring.
- Hang the indoor unit onto the mounting plate to mark the drilling hole. Then mark the drilling hole on the lower left of the indoor appliance.
- Remove the indoor appliance from the wall for drilling.

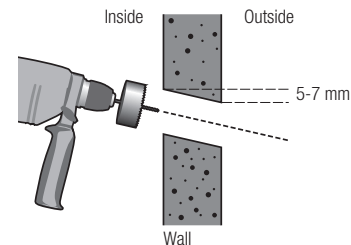

INSTALLATION OF THE CONDENSATION DRAINAGE HOSE

DRAIN

Bend the condensation drainage hose toward the bottom and always install the hose sloping down. Do NOT install the condensation drainage hose as shown in the illustration below.

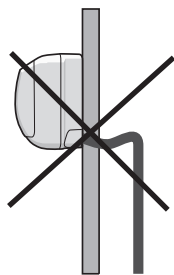

Do not obstruct the water flow by bending the hose.
Do not create an incline!

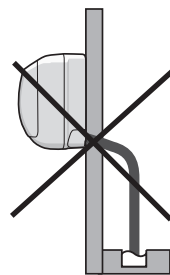
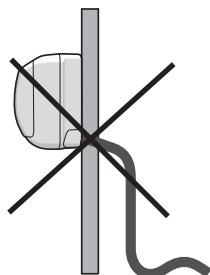

Do not place the end of the hose
in water

INSTALLATION OF THE CONDENSATION DRAINAGE HOSE

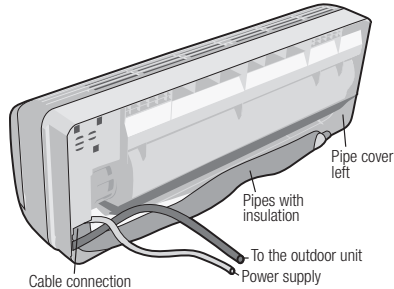

- When installing an extension of the condensation drainage hose, insulate the connecting part with a safety pipe and do not let the hose hang loosely.
- To install the condensation drainage hose on the left, install it as shown in the illustration. Bend the connecting tube to no more than 43 mm from the bending point to the straight line.
- Fasten the end of the condensation drainage hose.
- Connect the condensation drain on the indoor air conditioning unit tightly to the supplied condensation drainage hose.

INSTALLATION OF THE INDOOR UNIT

CAUTION

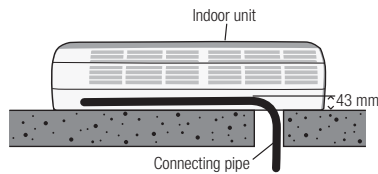

- First, connect the indoor unit, then the outdoor unit.
- Carefully bend and align the coolant lines.
- Do not let the coolant lines protrude from the back of the indoor unit.
- Make sure that the condensation drainage hose is not loose.
- Insulate both coolant lines at the connections.
- Always tie the condensation drainage hose under the coolant line.
- All lines must be placed inside of the indoor unit and may not protrude.
- Make sure that the pipes on the back of the indoor unit do not leak.
- Make sure that the condensation drainage hose is placed at the lowest point of the insulation package.
The condensation drainage hose must remain separate from the connecting pipe and cable to prevent condensate from overflowing.
- Please do not cross the power cord with any other cables.

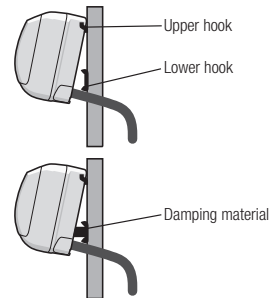

- Please let the condensation drainage hose hang down in a slope so that the condensate can drain without a problem.
- Insert the pipe through the bore into the indoor unit.
- Tighten the upper clamp on the back of the indoor unit at the upper hook of the installation plate and move the indoor unit from one side to the other to make sure that it is hooked securely.
- To simplify the connection of the pipe, lift the indoor unit away from the wall using padding, a screwdriver, or similar tool. When the connection is complete, remove the padding, screwdriver, or similar tool.
- Install the lower part of the indoor unit on the wall. Then move the indoor unit sideways and vertically to ensure that it is hooked securely.

INSTALLATION FOR QUICK-CONNECT LINES

EN

CONNECTING THE COOLANT LINE CAUTION!

- No traces of moisture or dirt may penetrate the adapter pipes and connections during the installation of the coolant lines. Always install the lines outdoors in dry weather. Do not remove any of the sealing caps and plugs until ready for installation. The installation must be performed in the sequence outlined below.
- Non-compliance with the individual installation steps according to these instructions and subsequent damage to the air conditioners will void all liability and warranty.
- The plastic caps must be removed from the pipe connections after the indoor wall air conditioner has been installed.
- The bending radius may not fall below 150 mm during the installation of the pre-filled coolant lines to prevent bending the coolant lines.

1.

Screw the coolant lines a few thread turns onto the pipe ends on the indoor air conditioner. It is absolutely necessary to make sure that only the thin tubes are connected with each other and only the thicker pipes are connected with each other. The thick pipes are marked in blue. If the thin lines are mixed with thick lines, the appliance will not work.

2.

Tighten the hand-tightened connections with two suitable open-end wrenches (never use pliers) to yield a gas-tight connection. The position of the open-end wrench at the pipe connection of the indoor air conditioner may not change during tightening because this would result in bending the coolant lines. Always hold an open-end wrench against it!

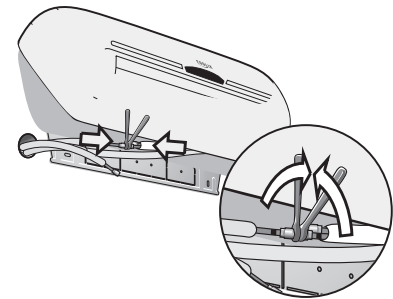

INSTALLATION FOR QUICK-CONNECT LINES

PIPE AND INSULATION

- Wrap tape around the connecting cable, the condensation drainage hose and coolant lines evenly (see illustration).
- The condensate from the indoor unit will flow to the collection tank and drain through the hose. Do not insert anything else in the container.

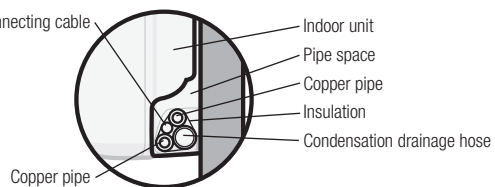
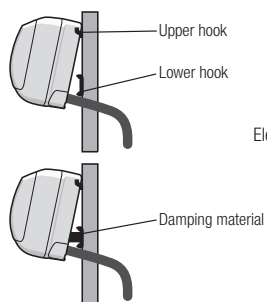

MOUNTING THE OUTDOOR UNIT

Preparations

- Install the outdoor unit on a solid surface to avoid high noise levels or vibration.
- Select the direction of the air outlet so that the discharge air flow is not blocked.
- If the installation location is located in an area that is exposed to extreme winds, such as at the ocean, make sure that the fan is functioning properly and mount the appliance along the wall or use a safety plate. In especially windy areas, you must mount the appliance so that air cannot penetrate the unit.
- When hanging the appliance, make sure that the mounts comply with the specifications indicated in the mounting diagram. The mounting wall should be made of concrete, brick, or similar construction. Utilise additional supports for strengthening. The connection between the mount and wall or mount and outdoor unit should thereby be solid, stable, and dependable.
- Make sure that the discharged air is not blocked.

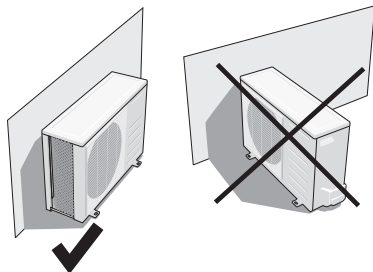

SETTING UP THE OUTDOOR UNIT

Secure the outdoor unit with anchors using screws and nuts with a diameter of \varnothing 10 or \varnothing 8 mm horizontally on a stable surface.

MOUNTING THE DRAIN PLUG

- Place the seal onto the drain plug and plug the drain plug into the bottom of the outdoor unit. Turn the plug by 90° to secure it.
- Connect the drain plug to the extension of the condensation drainage hose if condensation has accumulated during the "Heat" operating mode.
- Adhere to the floor clearance of 20 cm so that condensation can drain while heating in the winter and no icicles can develop from the condensation dripping down, which will then reach into the appliance.

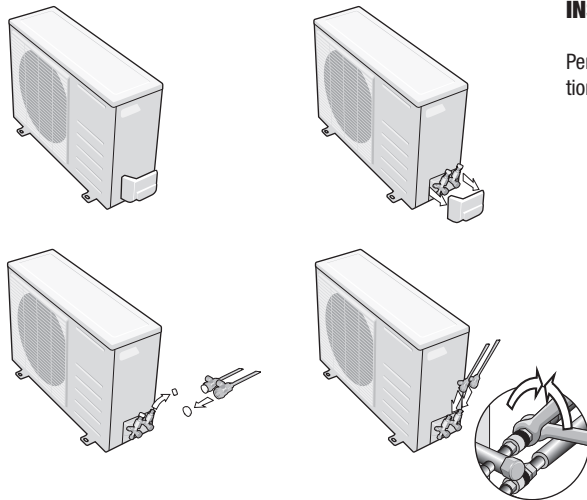

INSTALLING COOLANT LINES

Perform the installation for the outdoor air conditioner as already described for the indoor unit.

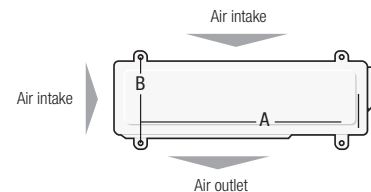

Model	A (mm)	A (mm)
≤ 16.000 BTU/h	458	250
≤ 16.000 BTU/h	530	290

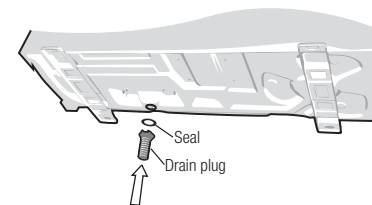

CAUTION

Never shorten the supplied copper pipes, even if they are too long. You can carefully roll up the excess meters and store them behind the outdoor unit.

INSTALLATION FOR QUICK-CONNECT LINES

SEAL TEST

Remove the sealing caps from both of the stop valves on the outdoor air conditioner. Use a wrench to slightly unscrew the valve on the thin lines counter-clockwise and immediately re-close it. The lines are now under coolant pressure and you can check the connections for tightness using soapy water. If the soapy water bubbles up, the seal is not tight. If this is the case, use the open-ended wrenches to retighten the screwed connections. Then insulate the connections with the supplied insulation to prevent condensation.

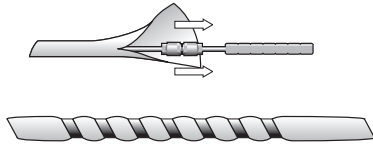

Insulating the connections

After the tightness check is complete, open both valves on the outdoor air conditioner using the wrench, unscrew them to the stop, and re-seal with the valve caps. The air conditioner cannot function unless the valves are completely opened up.

WIRING

- A power connection exclusively dedicated to the air conditioner must be provided.
- Make sure that the voltage complies with the rated voltage for the air conditioner.

Voltage	Fuse	Wiring
50 Hz 220-240V~	16A C - automatic cut-out	$\leq 1.5 \text{ mm}^2$

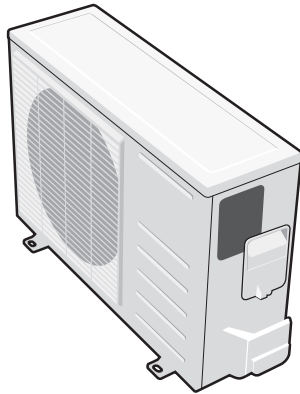

Power connection of the outdoor unit below the safety cover

CAUTION

- Only make the connections if the requirements are met.
- By law, short-circuit insulation must be provided at the installation location to prevent electric shock.
- Do not cut electrical wires to size to extend them.
- The voltage must range between 90% and 110% of the rated voltage.
- The electrical outlet for the air conditioner must be grounded. Therefore, a grounding receptacle must be used so that the air conditioner can be insulated effectively.

NOTE

Note in the sense of EMV Guideline 89/336/EWG: To prevent the flicker effect when starting the condenser (technical process), apply the following installation criteria:

- The air conditioner must be connected to the main power supply. The supply must have a low impedance; normally it is reached with at the melting point of 32 A.
- No other electrical appliances may be connected to the same power supply line.
- For more information about correct installation, contact the power company and make sure that there are no restrictions for the installation of products such as washing machines, air conditioners, and electric stoves.
- Please read the operating data on the product for information about the supply of the air conditioner.

CABLE CONNECTION

- Both connecting electrical cables must be connected through the mounted plug-coupling combination on the outdoor unit. However, this cannot be performed until the coolant lines have been connected.
- Remove the safety cap from the electric connection of the outdoor unit.
- Remove both screws from the pull relief.
- Now connect the plug from the indoor unit to the coupling on the outdoor unit.
- Place the electric cable under the pull relief and screw the two loosened screws back in.
- Reinstall safety cap for the electric connection of the outdoor unit.

START-UP

Plug in the power plug on the indoor unit. The air conditioner is now ready for operation. Perform the start-up as described in the operating instructions.

- Run the test operation after checking for gas leaks in the area of the adapter connections and after testing the electrical components.
- Connect the appliance to the power supply and press the "COOL" button on the remote control to start the test.
- Check all functions.
- Due to a safety function, the air conditioner will not start until 3 minutes after start-up or switching the switch.
- Make sure that the switch is set to OFF after the test operation.

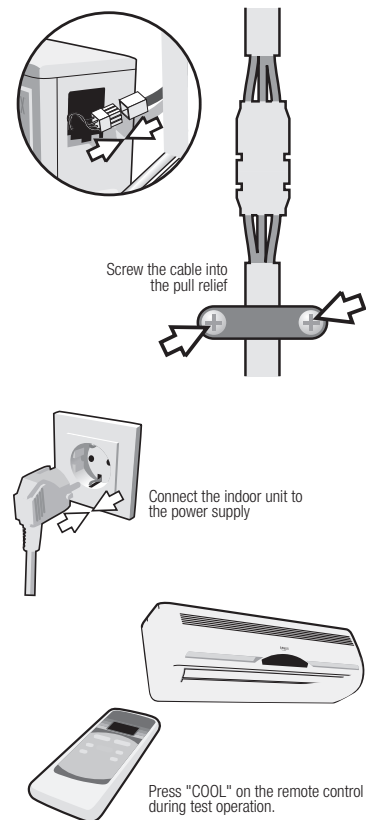

START-UP

The initial start-up of the appliance must be performed by the manufacturer or one of his authorised technicians.

All regulating, control, and safety devices must be checked for function and correct settings.

The start-up for the indoor unit must be performed and documented according to the operating instructions for the outdoor unit!

FUNCTION TEST FOR THE COOL OPERATING MODE

Proceed as follows during start-up:

- Turn on the power supply.
- Use the remote control to turn on the indoor unit.
- Use the TEMP button to set the desired temperature lower than the existing room temperature.
- Use the MODE button to set the COOL mode. Complete cooling is not achieved until 3 to 5 minutes later.
- Check the appliance control for functions described in the "Operation" section.
- Timer, temperature setting, fan speeds, and switching between Fan and Dehumidify modes.
- Note that cooling must discontinue if the desired temperature is set above the room temperature. This process may take about 1 minute.
- Measure all operating currents and check all safety functions.
- Check the function of the float switch, water tank, and water pump by pouring distilled water into the water tank.
- It is recommended to use a scoop bottle that can feed the water into the water tank.
- Please note that the water pump will permanently pump out accumulated water when the indoor appliance is working in the Cool or Dehumidify mode.

FUNCTION TEST FOR THE HEAT OPERATING MODE

Proceed as follows during start-up:

- Use the TEMP button to set the desired temperature higher than the existing room temperature.
- Press the MODE button to set the HEAT mode. Complete heat output is not achieved until 3 to 5 minutes later.
- Note that heating must discontinue if the desired temperature is set below the room temperature. This process may take about 1 minute.
- Measure all operating currents and check all safety functions.

CUSTOMER SERVICE AND WARRANTY

EN

FINAL MEASURES

- Train the operator on the appliance.

CUSTOMER SERVICE AND WARRANTY

The appliances were repeatedly tested for proper function at the factory. In the event that malfunctions occur that the operator cannot correct, please contact the customer service location listed in the operating instructions. Please note especially the WARRANTY section in the operating instructions.

Use or operation other than that listed in these operating instructions is prohibited.
Non-compliance will void any liability and warranty.

Intended use

The manufacturer is not liable for damages resulting from non-compliance with the manufacturer's specifications, statutory requirements or unauthorised changes to the appliances.

ENVIRONMENT AND RECYCLING

- Only qualified technicians may work on the cooling cycle. This ensures that no coolant will escape into the environment during repairs.
- Not only the coolant but also the parts of the appliance are subject to special requirements for disposal.
- The coolant that is used is part of the safety coolant group. This means that quantities that may be released in the event of damage will not cause injuries to human or animal respiratory organs.
- However, contact with liquid coolant may lead to freeze burns on the skin!

The rights to technical changes, mistakes, and printing errors reserved.